

Supplementary Figure 1a

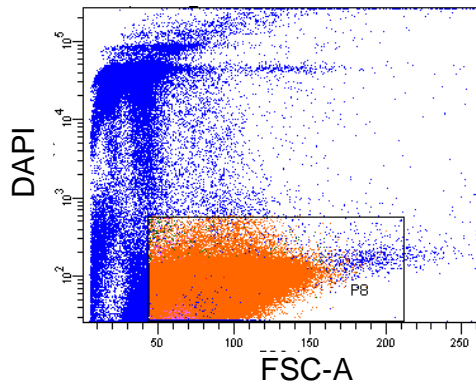

Supplementary Figure 1b

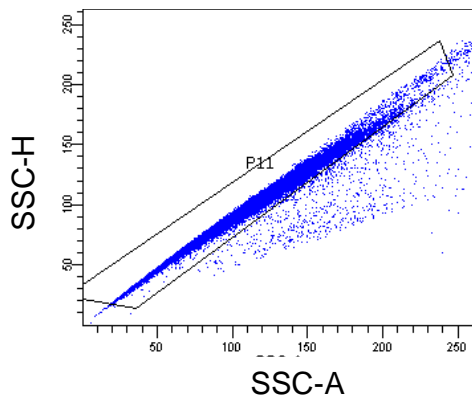

Supplementary Figure 1c

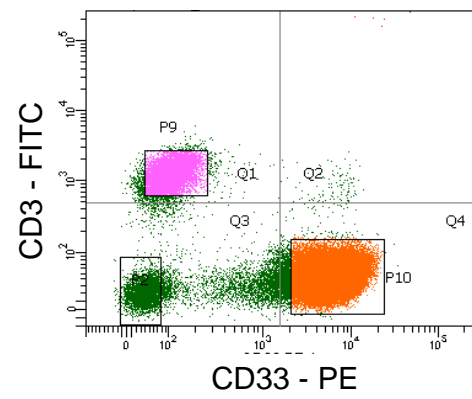

Supplementary Figure 1d

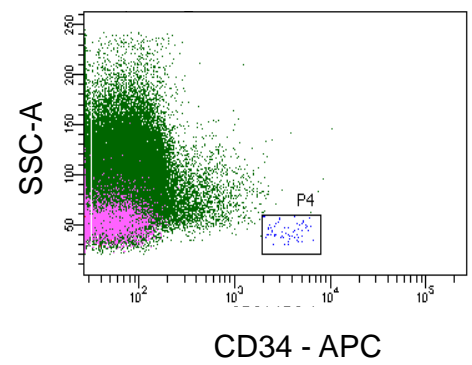

Supplementary Figure 2a – Mouse engraftment data for patient 7.

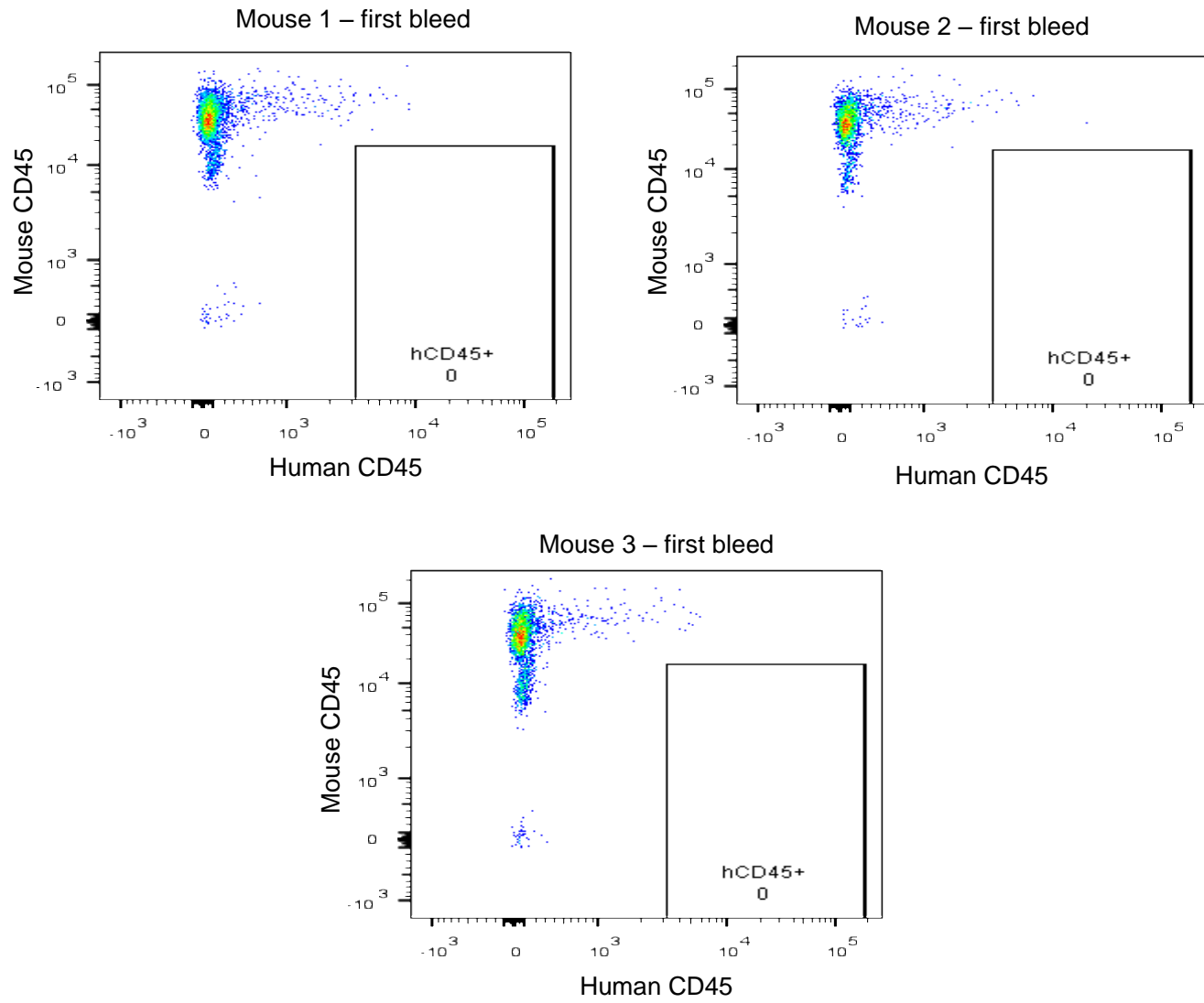

Supplementary Figure 2b – Mouse engraftment data for patient 7.

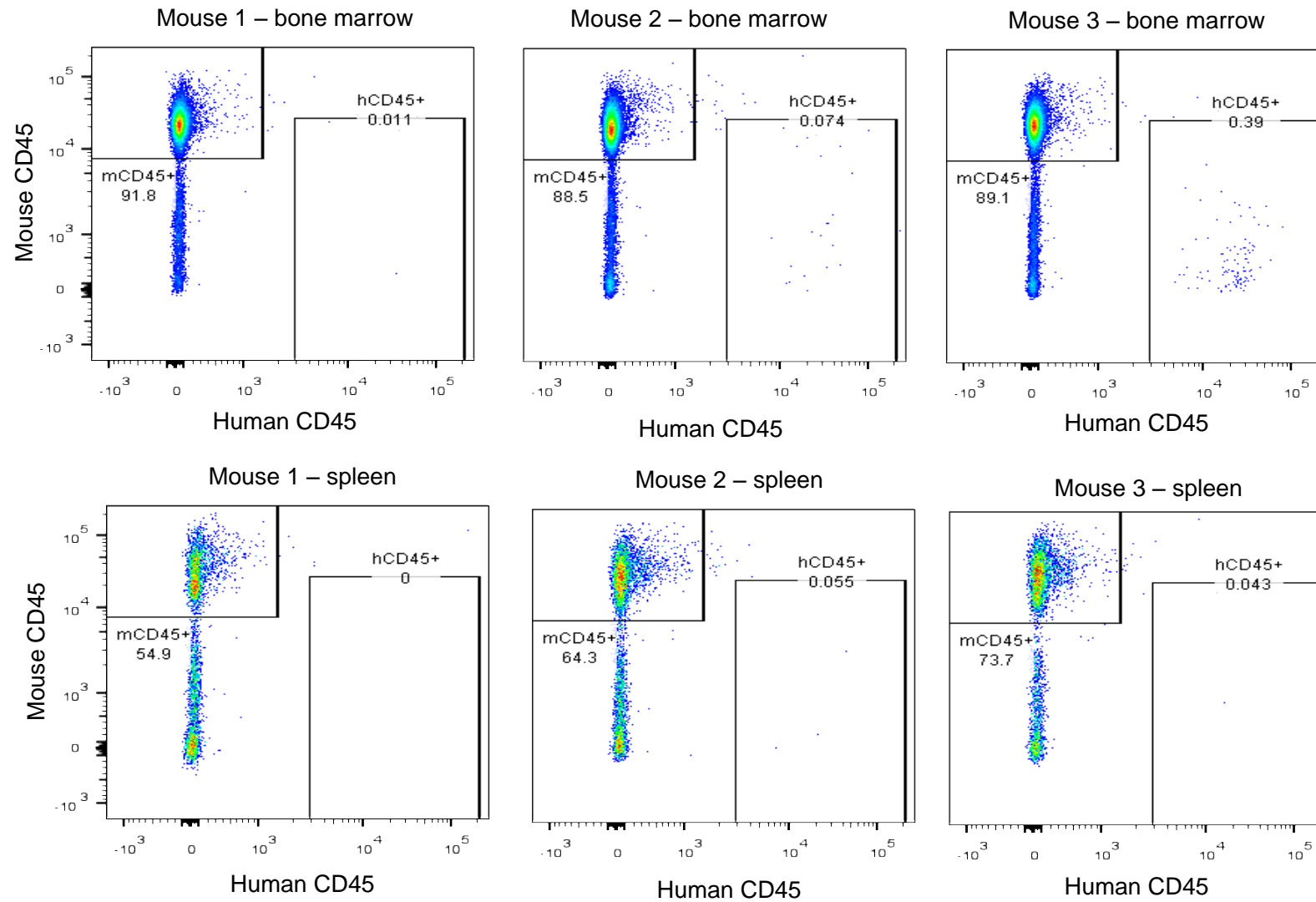

Supplementary Figure 3a – Mouse engraftment data for patient 3.

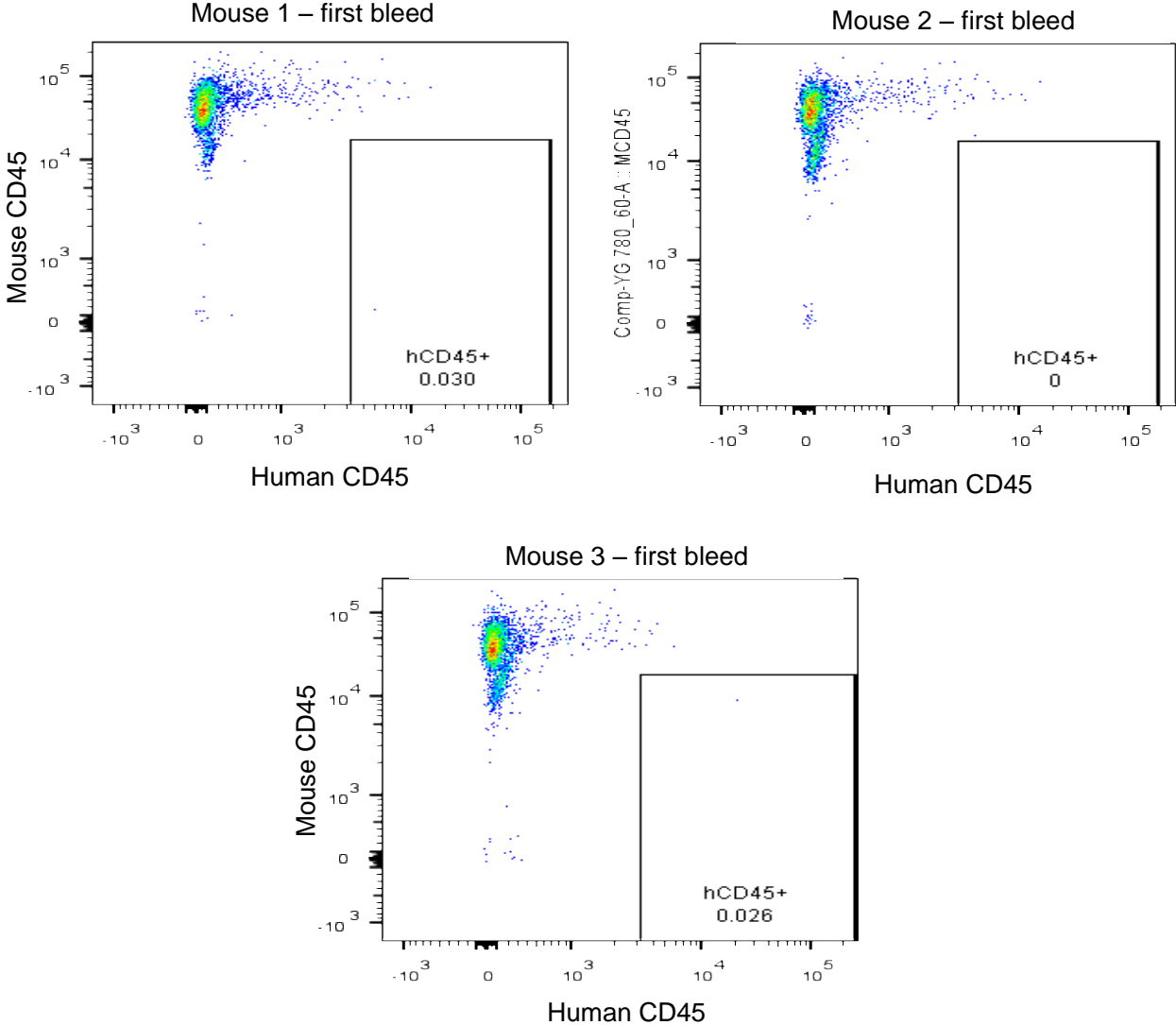

Supplementary Figure 3b – Mouse engraftment data for patient 3.

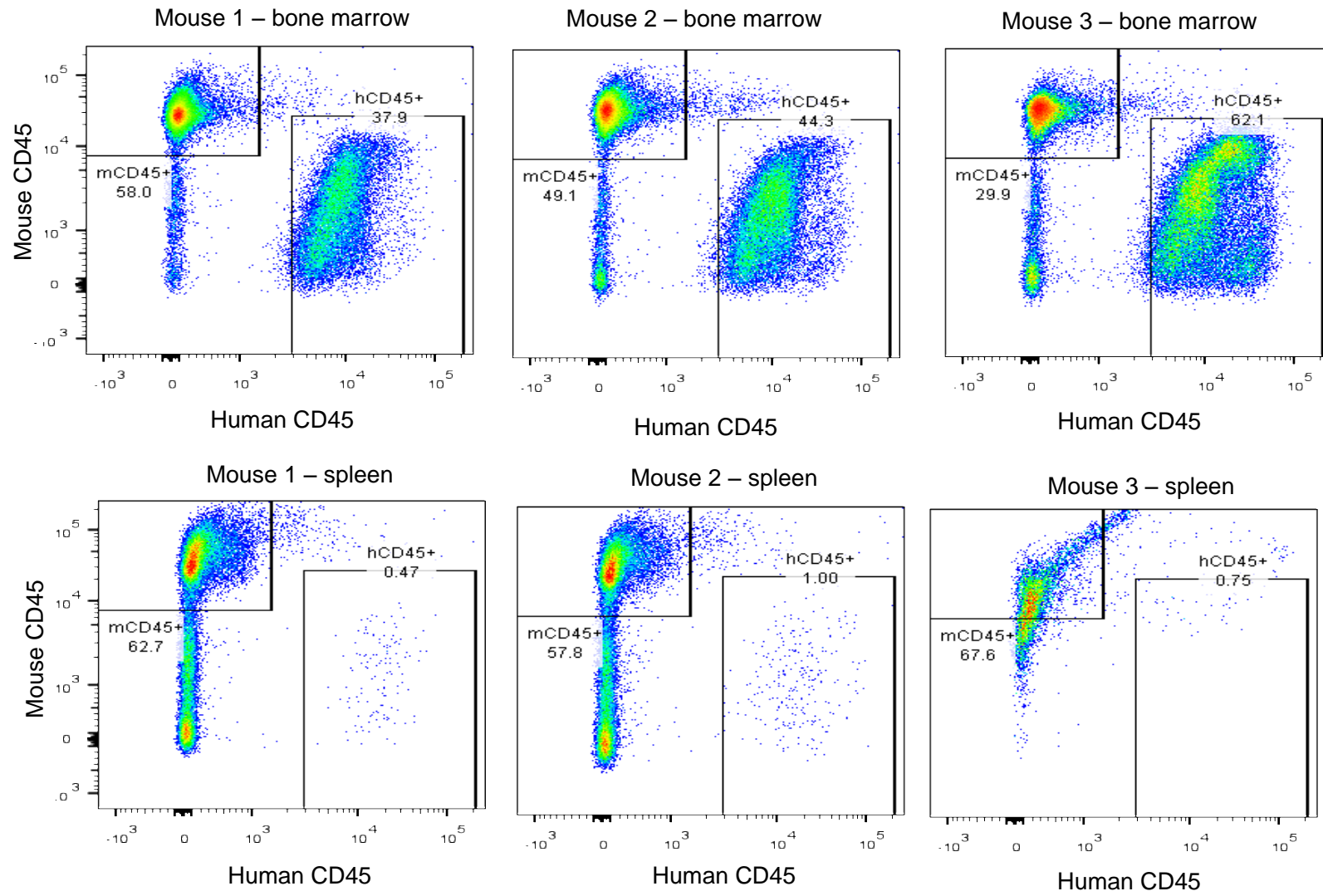

Supplementary Figure 4a - Comparison of mutant allele burdens and number of mutant positive single cells

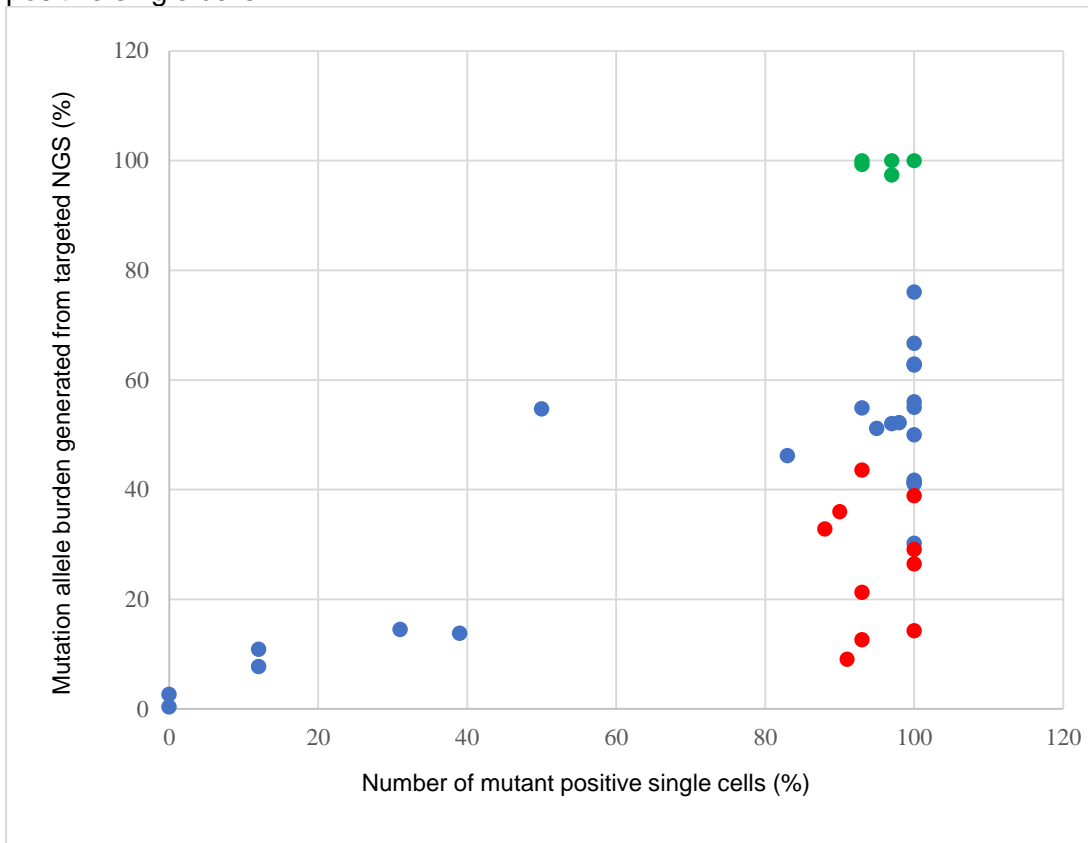

Supplementary Figure 4b - Comparison of mutant allele burdens and number of mutant positive single cells

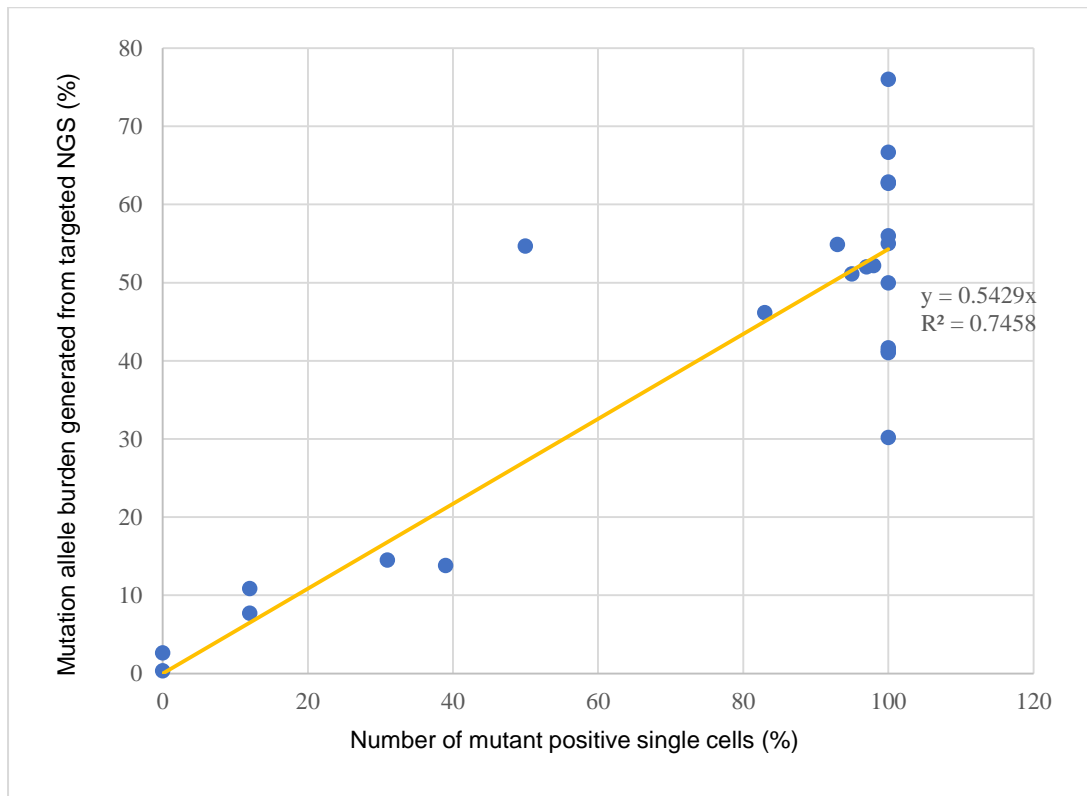

Supplementary Figure 5

Patient 1

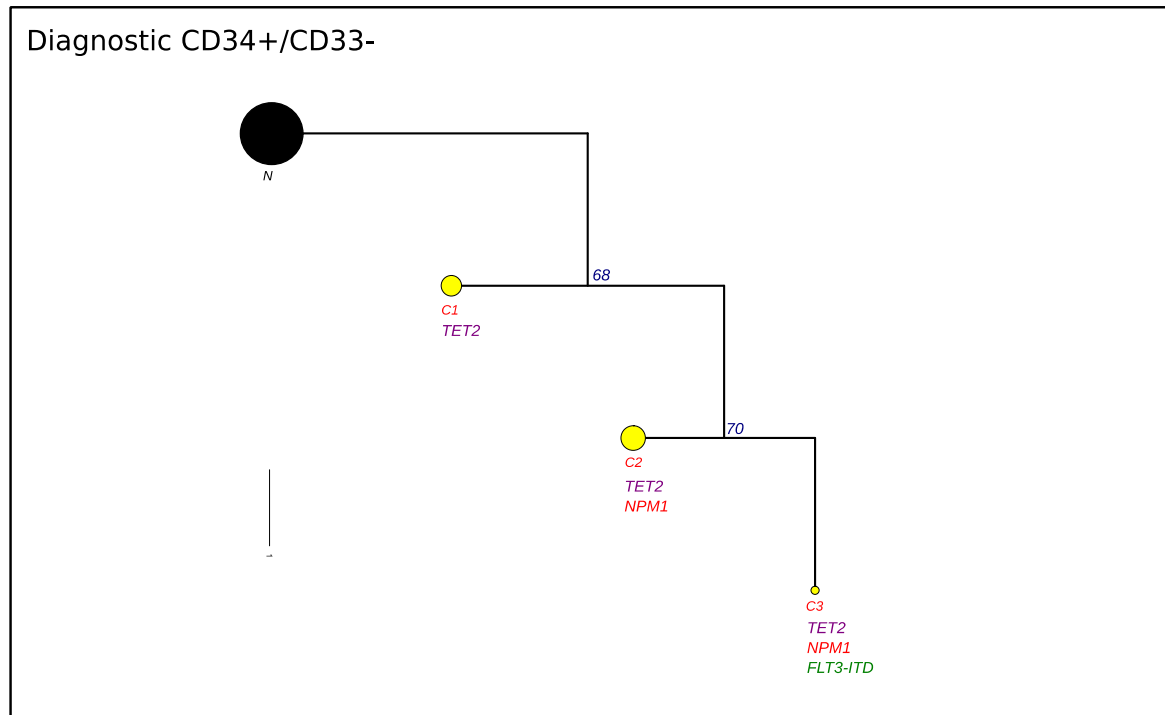
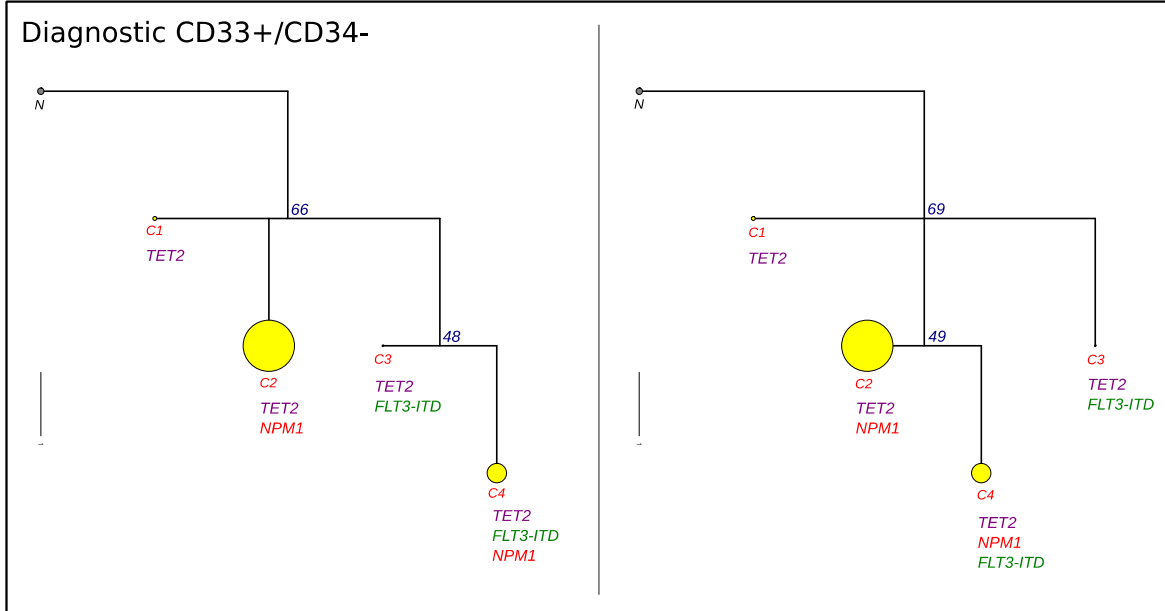

Patient 3

